

Article number: 437900185

Description: Rota-fix shaft-hub connection SA 185

Measures

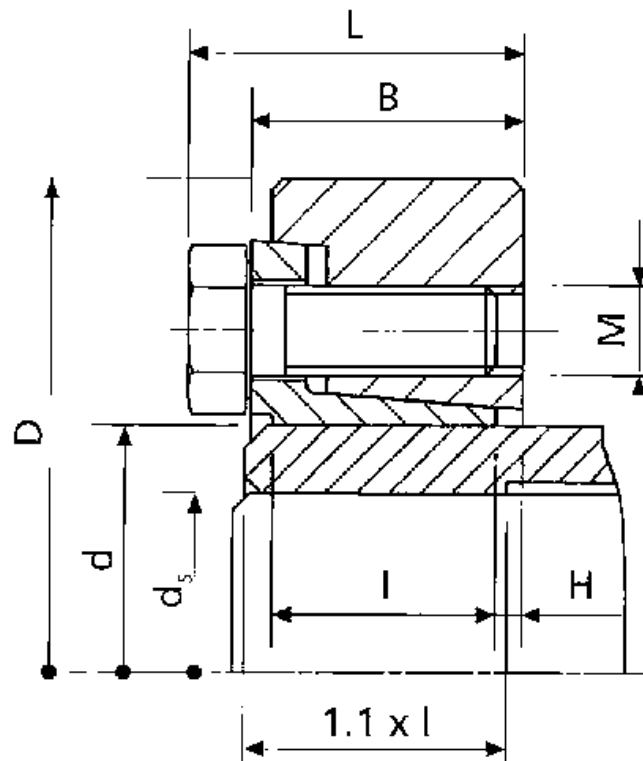

B mm	= 85.5
d H8 mm	= 185
D mm	= 320.0
ds mm	= 140
F kN torque	= 943
H	= 8.0
I mm	= 71.5
L mm	= 96.5

M mm	= M16
T N m torque	= 66000
Ts N m bolt tightening torque	= 250